

Shower Pan **1051-06**

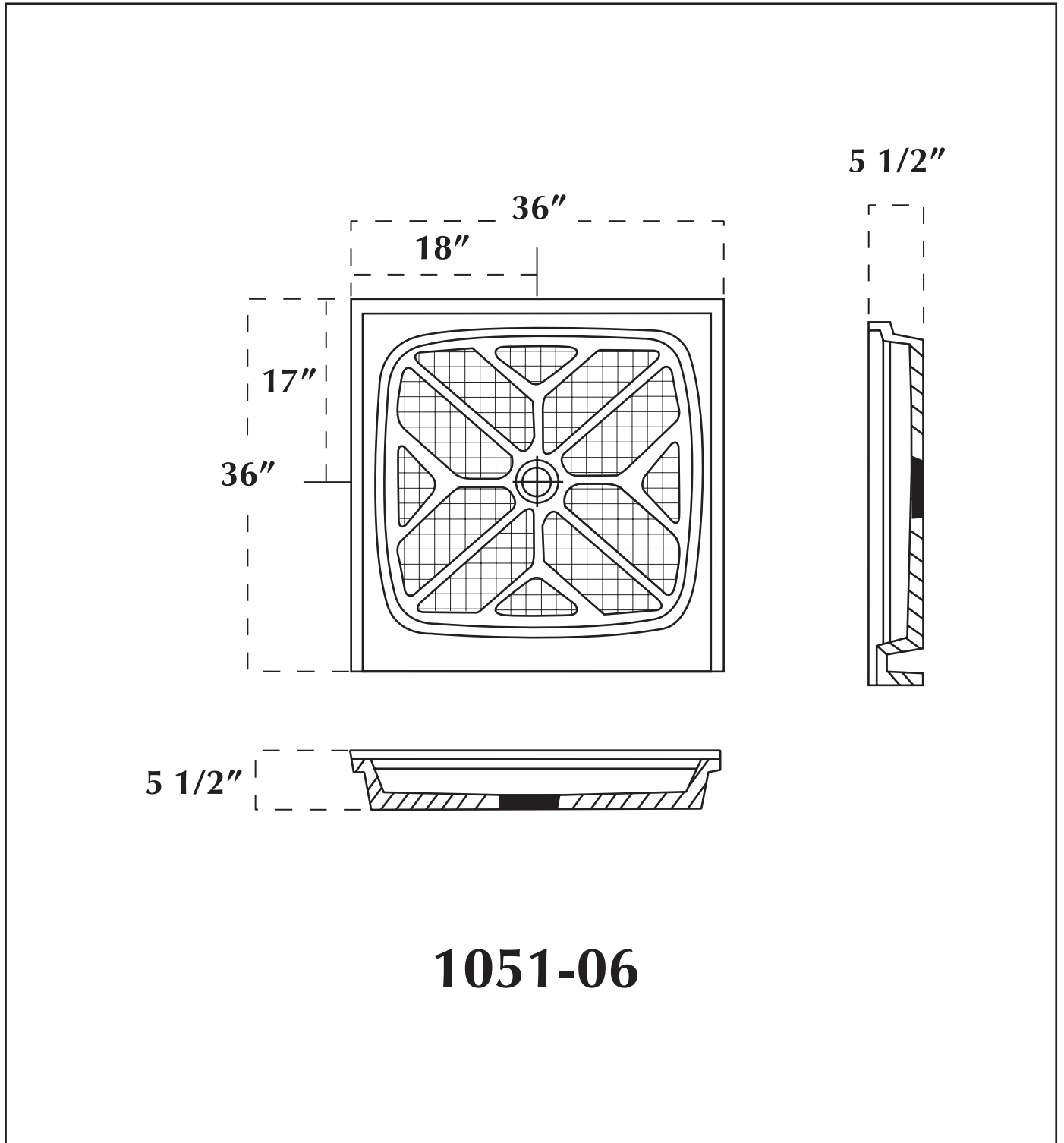

1051-06